

Article number: 12713000160100
Description: KLEE-coil 713 000 160.100
M16 Unhardened

Measures

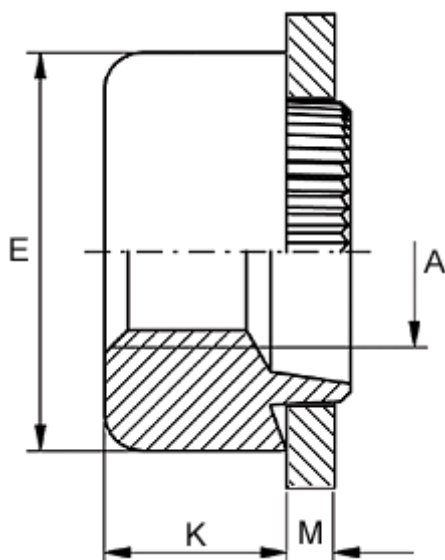

Female thread A	= M16
Height K	= 10.0
Outer diameter E	= 25.0
Plate thickness	= 3.5 to 3.7
Recommended bore diameter for extreme load	= 19.0
Recommended bore diameter for normal use	= 20.0